

T5 Electro Command RANGE

T5.100 | T5.110 | T5.120





A new breed of tractors for future focused farmers.

The new T5 Electro Command has redefined farming excellence for livestock, dairy and mixed farmers. The new T5 Electro Command is fruit of extensive customer consultation which means you can choose it, safe in the knowledge that it is right for your farm. Why? Because farmers just like you have been involved in its development.



T5 Electro Command. Built with versatility in mind.

New Holland knows that the T5 Electro Command will be used in a wide variety of applications, so it has been engineered by design to offer versatility as standard. Perfectly at home in the field, on the road, in the shed or in the yard, it can effortlessly turn its hand to transport, PTO, linkage or even municipal and groundcare applications. The Electro Command™ transmission enables you to easily and precisely adjust your speed to the task in hand. With a full range of PTO speeds, high visibility roof hatch as standard and front and rear linkage, you've found your perfect farming partner.

Electro Command models	Rated power hp(CV)	Wheelbase mm	Weight kg
T5.100	99	2380	4550
T5.110	107	2380	4550
T5.120	117	2380	4550



T5 Electro Command range: 3 models numerous applications

The new T5 Electro Command range's three models have been designed to ensure the perfect spread of power across the range. The entry-level T5.100 delivers 99hp(CV) which rises to the 117hp(CV) on the range-topping T5.120. This is all wrapped up in a compact package with high power-to-weight ratio, meaning the T5 packs a punch and delivers outstanding agility.

New T5 Electro Command. Multitasking becomes easier.

The new T5 Electro Command is helping to define modern livestock, dairy and mixed farming. Its eye catching New Holland styling includes the same design cues you expect in a T6 or T7 tractor. From distinctive cat eye lights, New Holland's signature LED lights and aggressive fish gill vents in the bonnet, the T5 will get heads turning. The tractor's overall compact dimensions and high power-to-weight ratio mean the T5 ticks all the right farming boxes.

Ultimate comfort. For the first time on the T5 Electro Command range, you can benefit from New Holland's renowned Terraglide™ front axle suspension, which helps ensure a silky smooth ride on even the roughest terrain; when paired with Comfort Ride™ cab suspension you've discovered the key to farming luxury.

Excellent efficiency. The T5 Electro Command's compact dimensions are home to the highly efficient FPT Industrial F5C engine with ECOBlue™ Compact HI-eSCR technology for Tier 4B compliance. It delivers increased performance and up to 24% more torque backup for even more productivity.

Outstanding versatility. The new wide frame front loader offers higher stability, even when working with the heaviest loads at maximum extension. The new in-cab joystick features transmission controls for effortless up and down shifting. This is all in a compact package: both standard and Comfort Ride™ cab suspension models come in at the same low overall height of 2.6m.

Increased productivity. The new LED lighting package turns day into night for true around the clock working. The new 1000 ECO PTO setting will see your productivity soar and your fuel consumption reduce. The all-new IntelliSteer® lite package delivers single-screen assisted guidance excellence.

New aggressive styling package

Optional New Holland LED signature lights

ECOBlue™ Compact HI-eSCR Tier 4B engine,
up to 117hp(CV) maximum horsepower

Multifunctional front linkage and PTO

Optional Terraglide™
front suspension

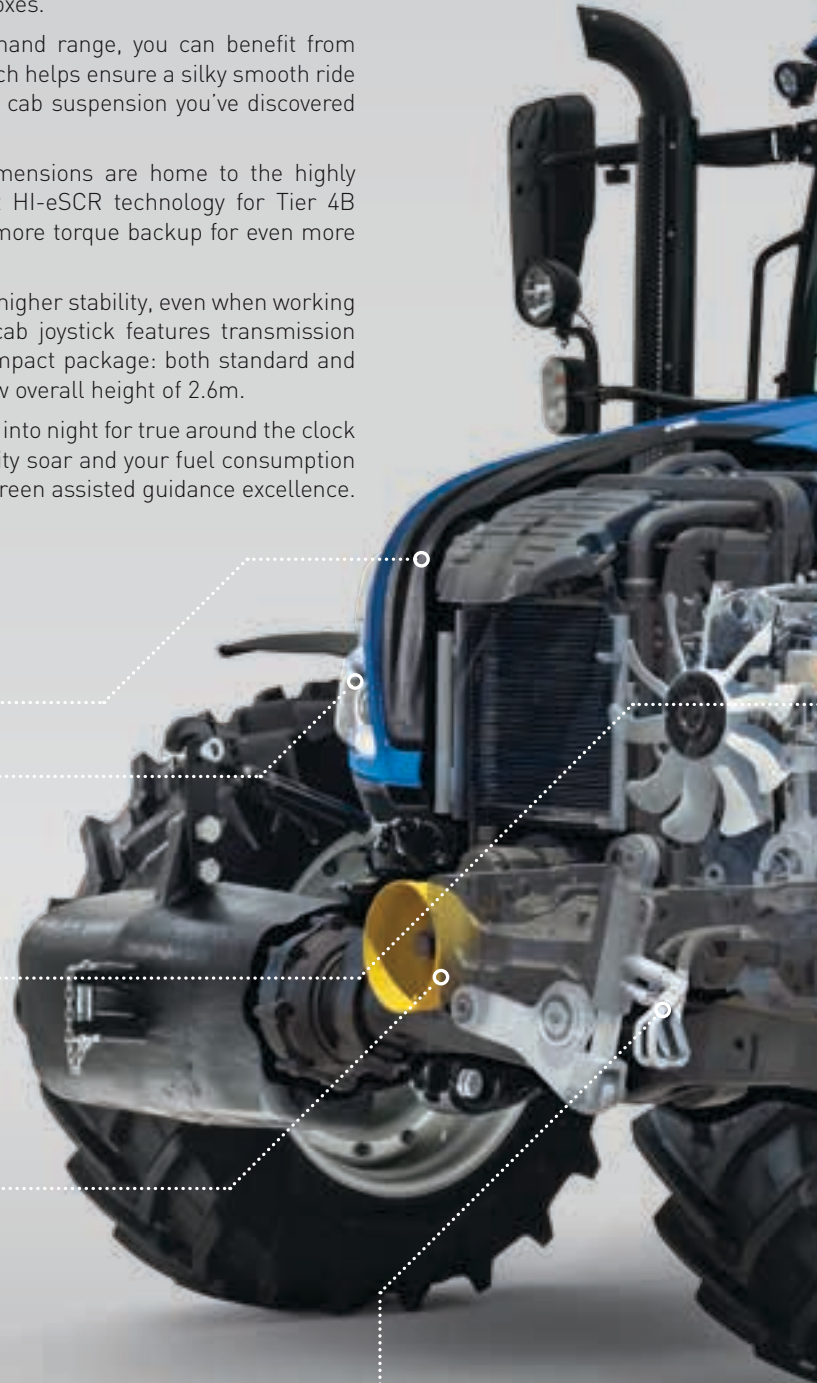



ISOBUS Class II compatibility

Hi-visibility roof panel

8 LED working lights option

Optional IntelliSteer® lite guidance system

Advanced seat options

Redesigned remote valve

Optional Comfort Ride™ cab suspension maintains standard tractor height

Increased rear linkage capacity

Factory installed wide Loader brackets



A new vision of cab comfort.

The deluxe VisionView™ cab has been designed around you for the ultimate operator experience. Panoramic visibility is guaranteed. Always. Keep an eagle eye on off-set mowers courtesy of the curved and openable side windows. Banish hitching nightmares: the extended rear windscreen guarantees a crystal clear view of the rear hitch. The repositioned exhaust means you've got acres of spaces to survey the road, or the field ahead. Precision position the tiltable steering column and dash to suit you. You'll be even more comfortable thanks to the Terraglide™ front suspension and Comfort Ride™ cab suspension which will cushion you even when travelling across the harshest terrain for a silky smooth ride.





Always keep an eye on your loader

The high visibility roof hatch has been engineered by design to offer a perfect view of the loader at full extension without having to crane your neck for enhanced comfort. The ultra thin band between the front screen and the high visibility roof hatch ensure the best visibility in the segment, enhancing loader productivity.



Eyes in the back of your head

The optional enlarged wing mirrors feature a top section for the best possible view of the road during high-speed transport. The adjustable lower section has been designed to effectively counteract blind spots.



Music to farm to

The full-size radio is simple to operate and makes selecting your favourite station on the go even easier thanks to its optimal dimensions. For music lovers a MP3 auxiliary plug, together with its own personal pocket, is also available.



Climate control just got even cooler

The all-new air conditioning system features dual fan technology to guarantee high performance in even the hottest summers and in the very bitterest of winters. Individually position up to 10 vents to control the airflow for ultimate all-body comfort or super-fast defrosting of the windscreen. The B pillar mounted controls fall perfectly to hand and can be intuitively adjusted whilst on the move.

Command Arc: the ultimate ergonomic farming experience.

The cab controls have been designed around you, the farmer. How? Well, you were at the heart of the design phase. Developed and tested using state of the art virtual reality techniques, and refined with our virtual farmer Jack, all principal controls are grouped on the Command Arc. This ergonomic cluster means you can perform the most frequently used operations without excessive twisting for superior productivity and reduced fatigue.



All switches are back lit for even easier operation when working late into the night. This function is automatically activated when working lights are engaged.

A dedicated Ground Speed PTO can be specified. Perfect when spreading slurry or lifting turf. Protect your implements and tractor with the soft-start PTO setting. Auto PTO will disengage and re-engage the PTO during a headland turn.

The mechanical or electronic joystick controls up to four mid-mount remotes, ideal for operating a front loader with ease from the comfort of the driver's seat.

Fine tune your speed with the easy to use hand throttle.

The advanced EDC controls are ideally placed to fine-tune drop rate, the height limiter, sensitivity and slip for uniform cultivation and maximum traction.

Integrated de clutch and up gear and down gear shift buttons for enhanced loader productivity.

Ergonomically positioned main gear lever and park lock engagement.

Command Arc up and downshift buttons offer fingertip gear changing.

New remote lever locks for increased safety.

Up to three remote valves and one diverter are smoothly and ergonomically engaged with the dedicated levers.



IntelliView™
touchscreen monitor:



Front and Rear PTO is positively and safely started and stopped courtesy of the push-pull switches.

Engage Terralock and it will automatically manage four-wheel drive and differential lock selection.

Three setting Powershuttle aggressiveness switch.

The dedicated rocker switch to engage the optional Creeper.

Use Engine Speed Management to pre-set two engine speeds.



The best seat on the farm.

New Holland brings to you the best-in class seat offering, with two different seat options providing you with a wide and comprehensive choice. All seats benefit from improved cushioning. These firmer, more durable seat cushions provide outstanding comfort whatever the terrain.



Auto Comfort™ seat

If you spend extended hours in the tractor, the enhanced comfort of the heated, semi-active Auto Comfort™ Seat, fitted with a large air reservoir to counteract ground undulations, means you'll enjoy the smoothest ride, ever.



Deluxe air-suspension seat

The standard seat uses a deluxe air suspension unit which can be precision adjusted to suit each operator. Seat cushions are finished in a durable dark blue cloth, and all controls are easily identifiable for quick and easy adjustment.



A full sized matching upholstered instructor seat with seat belt completes the comprehensive seating offering.

Bright lights for dark nights.

Lighting up the way for improved night time productivity and total safety is a New Holland key priority, accomplished by bringing into the farming world the latest automotive sector innovations, such as LED lights. The all-new lighting offering features up to 8 LED lights. Brighter and less power-consuming than their standard equivalent, these lights offer a broad spread of white light, turning night into day. Four rear and two front roof lights, together with two LED lights on the cab rail and high level headlamps light the road or field ahead and help round the clock farming. A standard halogen option is also available.



Fully adjustable lights

The 360° LED lighting package offers adjustable lights at the front and rear of the cab. LED lights are super efficient offering more light, more durability with less power consumption.

The optional signature lights bring a modern stylish addition to the familiar New Holland hood lights, there's even a New Holland logo within the light unit.

Tailor made PLM[®] packages.

New Holland knows that each farmer has their own autoguidance requirements, and that is why you have the choice between three different solutions across the T5 Electro Command range. The entry-level manual guidance option uses an easy to follow lightbar to keep you on the straight and narrow, perfect for fertilizer spreading. The EZ-Pilot™ option can be retrofitted. Featuring a steering motor and compatible with the separate FM-750 display, this is the ideal solution when cultivating. The range-topping IntelliSteer[®] lite solution is managed through the existing IntelliView™ colour touchscreen monitor, keeping the cab uncluttered and delivers outstanding accuracy, as high as 1.5cm when used with an RTK correction signal. The default choice when planting high value vegetable crops.

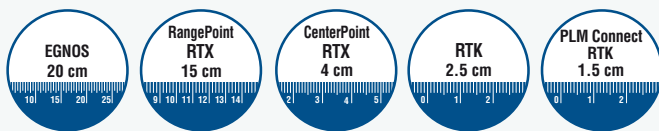

Levels of accuracy and repeatability

New Holland offer multiple levels of accuracy. This enables you to select the right accuracy to match your needs and budget. When using RTK correction with IntelliSteer you can enjoy guaranteed year on year repeatability.



ISOBUS compatibility

The entire T5 Electro Command range can be specified with optional ISOBUS II. What does that mean? Quite simply, you can use the optional IntelliView III monitor for single screen operation of any ISOBUS compatibility implement attached. Simple plug and play.



IntelliSteer[®] lite. Intelligent assisted guidance.

The all-new IntelliSteer[®] lite solution offers the user experience of traditional IntelliSteer[®] fully integrated autoguidance with the flexibility of being able to quickly and easily remove it and install it on another machine on your farm. Perfect during harvest, when you can simply remove it from your T5 and install on your New Holland combine. Controlled through the in-cab IntelliView™ colour touchscreen monitor, this intuitive system offers get in and go efficiently, with pass-on-pass and year-on-year repeatability as high as 1.5cm when used with an RTK correction signal.

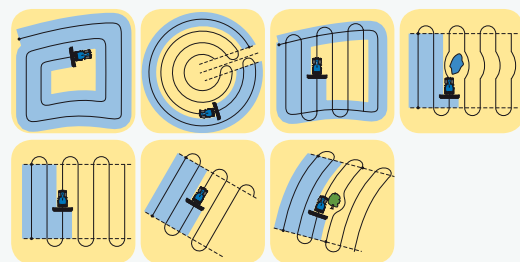

IntelliView™ - visible intelligence

The ultra-widescreen 26.4cm IntelliView™ IV colour touchscreen monitor can be used to manage the optional IntelliSteer[®] lite autoguidance system. The IntelliView™ monitors enable fingertip programming of a variety of guidance paths, from straight A-B runs to the most complex adaptive curves. You can personalize your settings simply and easily and also transfer data using PLM[®] Connect File Transfer and PLM[®] desktop software packages.



The simple hands-free farming system

EZ-Pilot™ is a simple aftermarket hands-free assisted guidance solution. The steering wheel is turned for you courtesy of a fully integrated control module, which you manage via the advanced FM-750 display. For customers who are looking for the ultimate aftermarket solution, Autopilot™ is compatible with T5 Electro Command tractors.

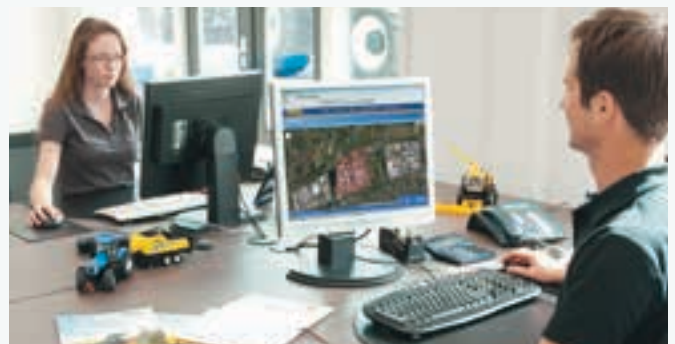

Telematics: manage your machine from the comfort of your office

PLM® Connect enables you to connect to your T5 Electro Command from the comfort of your office through the utilization of the mobile network. You can stay in touch with your machines at all times, and you can even send and receive real-time information that saves time and enhances productivity. The entry-level PLM® Connect Essential package offers the most frequently used features or upgrade to the PLM® Connect Professional package for full machine monitoring and control. In short, PLM® Connect will help you to reduce your fuel bills and improve fleet management and security in one simple package.

Clean performance. Responsive productivity.

The entire T5 Electro Command range boasts 3.4 litre Common Rail F5C engines developed and produced by FPT Industrial that fully comply with the stringent Tier 4B emissions regulations. The optimised, powerful, super-quiet engines develop between 99 - 117hp(CV), have up to 491Nm of max. torque and have 24% more torque backup for guaranteed productivity. Throw in a power-to-weight ratio of just 38.9kg/hp(CV) and the T5 is your perfect farming partner. The entire T5 Electro Command range will use a ECOBlue™ Compact HI-eSCR and Low Rate Exhaust Gas Recirculation (EGR) for Tier 4B compliance. This is in alignment with the New Holland Tier 4B strategy, which foresees the use of Compact SCR and Low Rate EGR for lower powered products with reduced cooling requirements and for which overall product dimensions are of vital importance. It all adds up to outstanding efficiency. What you've come to expect of the Clean Energy Leader®.

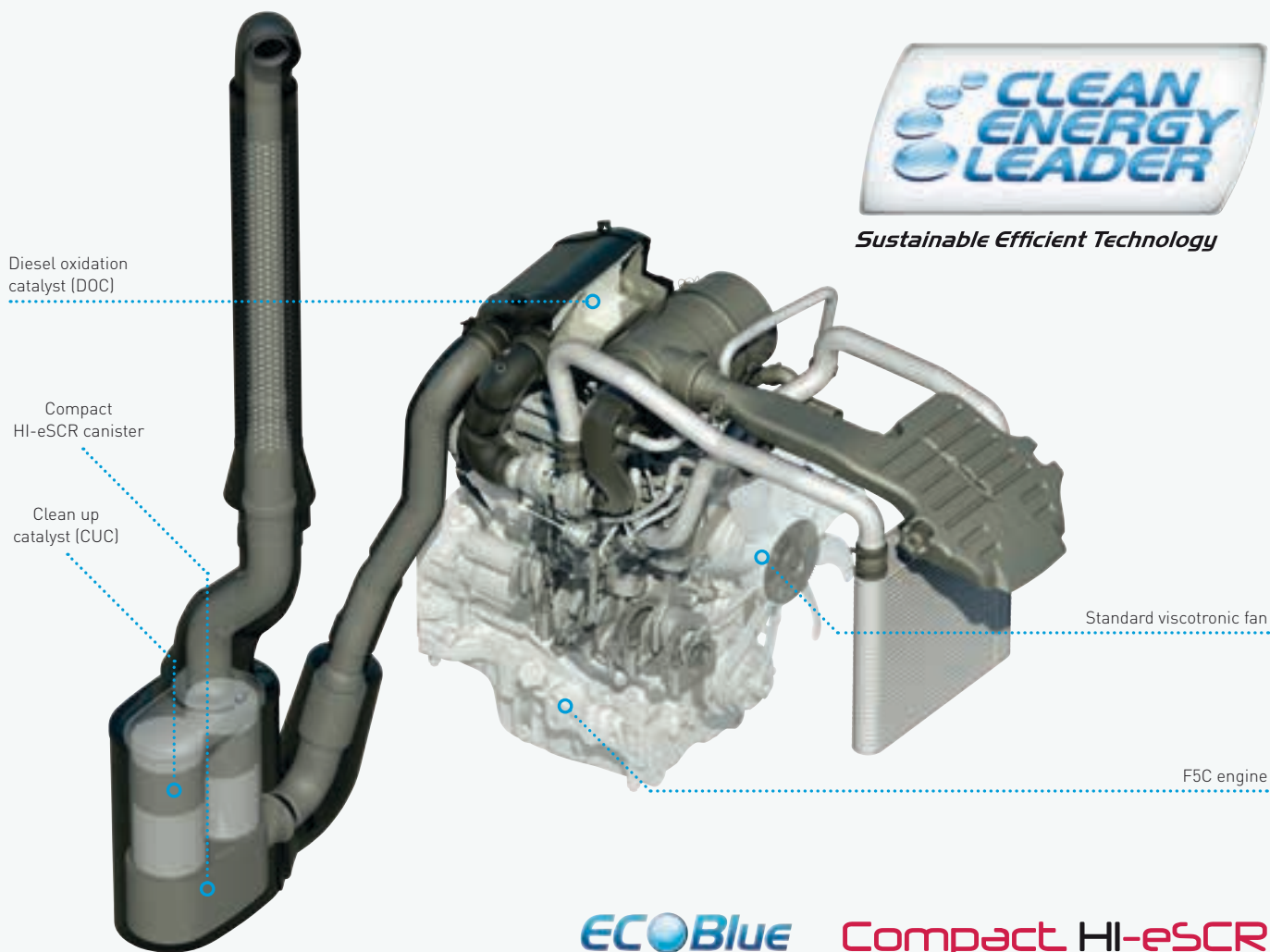

ECOBBlue™ Compact HI-eSCR explained

Specifically designed for the F5C engine, FPT Industrial developed a compact version of its HI-eSCR, an evolution of the existing ECOBlue™ SCR system, you will benefit from the highest NOx conversion efficiency in the industry. This multi-patented system uses a new Engine Control Unit, which not only manages the engine, but also the HI-eSCR

after treatment system by controlling the supply and dosing modules. Using a dedicated closed loop system, it continuously monitors the NOx levels in the exhaust gases, ensuring that during every cycle the precise amount of AdBlue is injected to achieve NOx conversion of over 95%, all while guaranteeing low fluid consumption.

Powered by FPT Industrial

New Holland are not going it alone when it comes to Tier 4 technology, they can draw on the experience of their in-house engine development specialist: FPT Industrial.

Pioneers: Common Rail technology developed by FPT Industrial at their R&D excellence center in Arbon, Switzerland in the 1980s and brought it to the masses in 1997 on the Alfa Romeo 156. They were the very first to introduce it on agricultural machines on the TS-A tractor. Pioneering. Always.

Cleaner: for the sixth consecutive year, CNH Industrial has topped the Dow Jones Sustainability World and Europe Indexes for the Industrial Engineering sector. Cleaner. Everywhere.

Proven: FPT Industrial has pioneered SCR technology since 1995 and has already produced over 650,000 SCR engines during the last eight years for the agricultural, construction and haulage industries. Reliability. Confirmed.

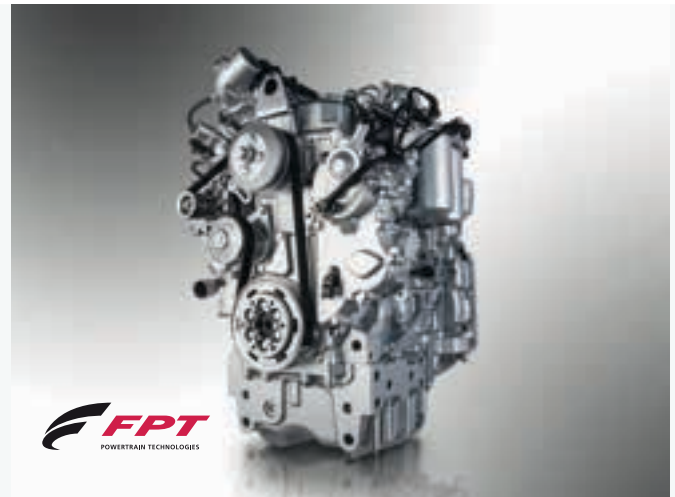

More time working, less time maintaining

Advanced engineering design means lower maintenance demands. All T5 Electro Command models benefit from New Holland's industry leading 600-hour service intervals, and they all run on easily available standard oils. Choose New Holland to save money, downtime and to protect the environment.

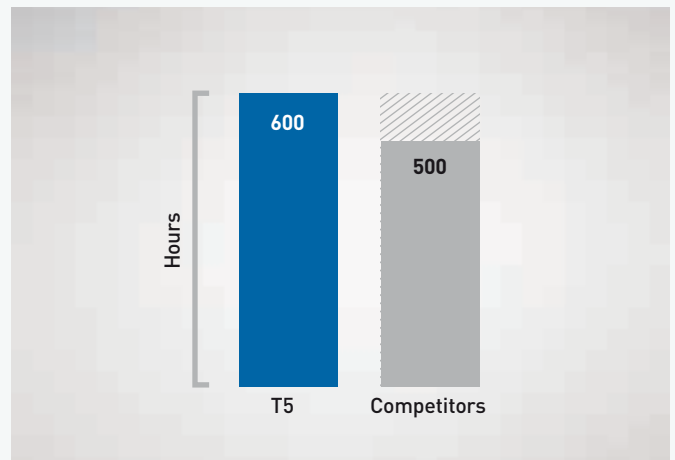

Maintaining performance. Always.

Here at New Holland we're passionate about transient response. Put simply, as your F5C engine is equipped with the new Compact HI-eSCR, it can react even quicker when placed under load. Therefore, when you're transporting fully laden grain trailers and you encounter a hill, you'll be able to maintain constant forward speed.

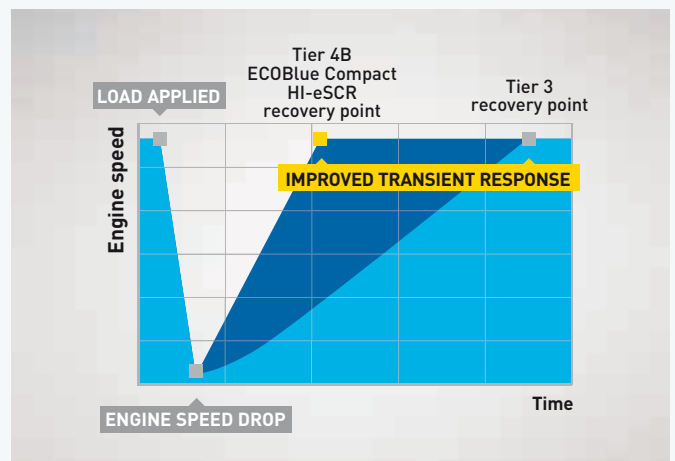

Simple ESM. Taking the hassle out of throttle control.

A versatile tractor needs to be equally suited to PTO and heavy draft applications. With Engine Speed Management (ESM) the advanced engine management system will precisely fuel the engine so it will accommodate fluctuations in engine load whilst maintaining the desired engine speed. For convenience, two engine speeds can be memorised. You can then simply toggle between the speeds using a button on the transmission controller.



Semi-powershift technology.

New Holland knows that every farm has different requirements, and that intelligent innovation also means offering tried and tested solutions to improve efficiency. The semi-powershift Electro Command™ transmission offers clutchless gear changes to reduce fatigue, and gear shifting is taken care of for you with the addition of the optional Auto Modes.

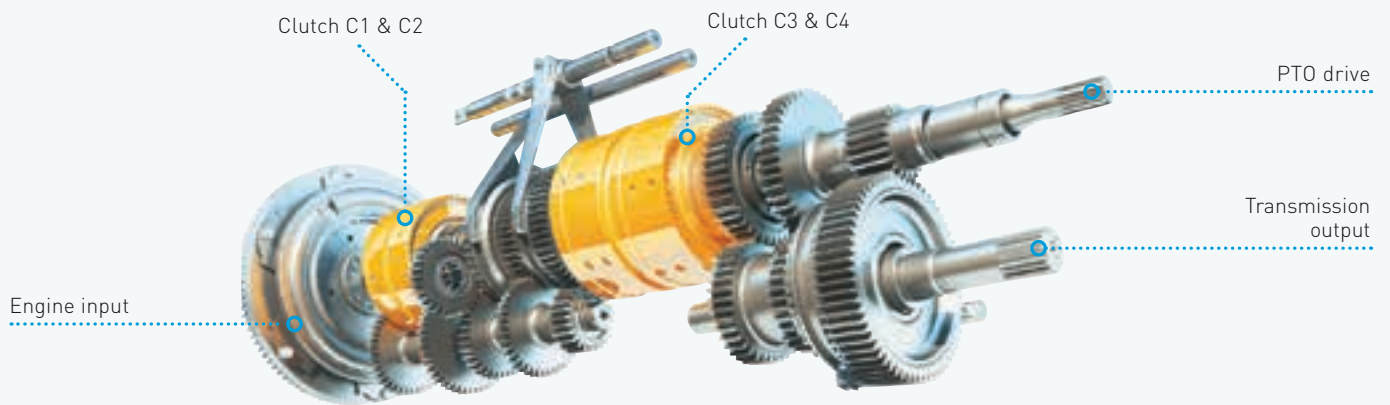

Electro Command™

The Electro Command™, semi-powershift transmission allows you to select eight gear speeds via up and downshift buttons on the main gear lever. The third button selects the range change. If you prefer, you can also change up and down using the buttons ergonomically positioned on the Command Arc or Hydraulic joystick when fitted. You can see the selected gear at a glance thanks to the large gear display. Top transport speeds of 40kph are achieved at a mere 1970rpm. The result? Your T5 will slash your fuel bills whilst reducing in-cab noise.

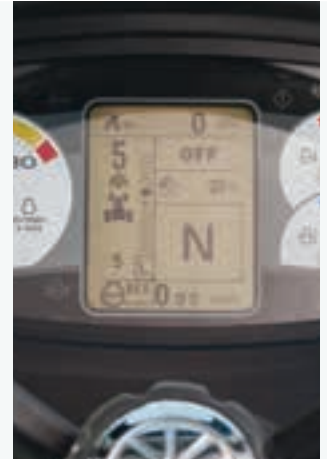

Work together: automation, comfort and productivity

Auto Transport mode simplifies gear changing and reduces operator input during road work. It can even sense if the tractor is being pushed by a loaded trailer and holds the current gear to provide engine braking.

Auto Field manages both the engine speed and transmission to optimize performance and economy in PTO and draft applications.

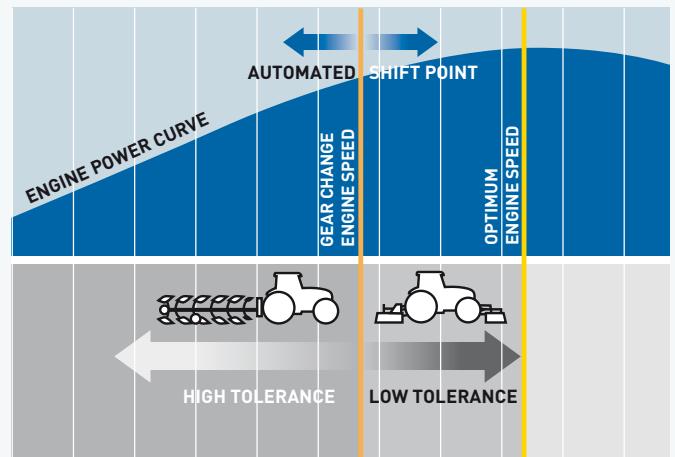

Ergonomic Powershuttle

The column-mounted electro hydraulic Powershuttle can be operated without having to take your hand off the wheel for increased safety during loader work. You can even regulate the aggressiveness setting with an ergonomically positioned switch on the Command Arc. Select soft for general field work, standard for daily tasks and the super aggressive position for near-instantaneous direction changes during loader work. Want more? You can even change the setting whilst on the move.



Super safe mechanical park lock

If you work in very hilly terrain, then the mechanical park lock will give you additional peace of mind. This system is mechanically engaged via a dedicated position on the main gear lever, and it mechanically locks the gears to prevent even the slightest forward or reverse creep when parked on any slope. This is especially beneficial when towing fully laden trailers.



Outstanding traction. Unsurpassed comfort.

Combining the powerful action of Terraglide™ front axle suspension, Comfort Ride™ cab suspension and suspended seat, you can experience a smooth ride, whatever the road or soil conditions, with great benefits in terms of comfort, driving pleasure and reduced fatigue. When selected Terraglide™ front axle suspension can be locked, raised or lowered depending on individual application requirements.

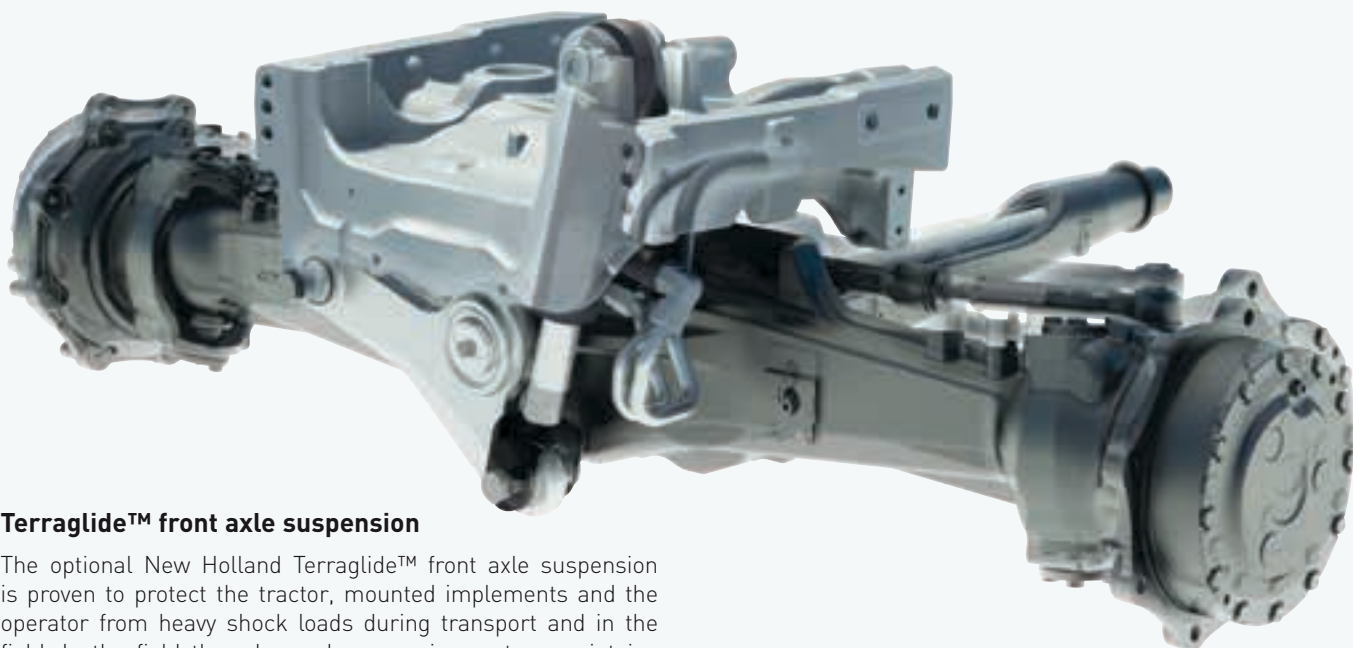

Terraglide™ front axle suspension

The optional New Holland Terraglide™ front axle suspension is proven to protect the tractor, mounted implements and the operator from heavy shock loads during transport and in the field. In the field the advanced suspension system maintains contact between the tyre and the ground to improve traction. Full suspension travel is always maintained and two accumulators further increase performance during light and medium loads.

Integrated Comfort Ride™ Cab suspension

The optional automatic two stage Comfort Ride™ cab suspension has established itself as a key advance in operator comfort. It provides up to a 25% reduction in shock loads reaching the operator. Designed to complement the cushioned ride offered by the air suspension seat. It is ideal for operations that include fast top work and extended transport duties.





Terralock™ automatic traction management

New Holland's renowned Terralock™ solution is simple to setup and operate. It automatically manages the engagement of drive to the front axle, locking both the front and rear differentials. Forward speed and steering angle information dictate when the differential locks and, if required, four wheel drive disengages. Why? To guarantee the tightest turning circles and to reduce strain on the driveline.



Heavy duty axles for high speed transport

Heavy duty, 275mm flange rear axles have been combined with larger diameter brake discs to deliver impressive stopping performance, even when transporting heavy fully laden trailers.



Tyres. The choice is yours.

It's access all areas with ultimate soil respect for the new T5 Electro Command. A whole host of tyres are available, including the largest R38 tyres with improved ground clearance, perfect for vegetable growers that, thanks to their large footprint, also reduce compaction and improve traction. Hard wearing municipality, forestry and turf tyres complete the line-up. With New Holland, choice comes as standard.

Productivity and flexibility guaranteed.

New Holland knows that full integration is by far the best design option. That is why the T5 Electro Command was designed with front loaders and front linkage in mind. The T5 Electro Command is fully compatible with the new Wide Frame New Holland 700TL range of front loaders: the perfect productivity combination. Moreover, you no longer have to choose between front loader or front linkage, with the new T5 you can have both.



High capacity rear linkage

Measured at the ball ends, the rear linkage has a maximum lift capacity of up to 5420kg. The fender mounted rear linkage and PTO controls mean that you can hitch even the most difficult implements in absolute safety and comfort.



Multifunctional front linkage and PTO for enhanced flexibility

The factory fitted front linkage can lift up to 1850kg and the 1000-speed PTO further enhance this range's outstanding versatility. The optional multi-function front axle support provides further flexibility for the future. This design allows the choice between an integrated front weight carrier, front linkage, front PTO (perfect for municipalities) or the range-topping front linkage and PTO combination, should a change in business focus occur.



Long, strong, productive

The wide frame 700TL range's vital statistics are rather impressive: maximum lift heights of 4.07 metres and lift capacities of up to 2304kg mean that no task is too big or too small. The numbers speak for themselves. But there's more. The hydraulic pipe work has been integrated into the loader frame to significantly improve forward visibility for precision operation and to prevent potential snagging when operating in the lowest sheds.

FOPS: your safety partner

New Holland offers you the ultimate in loader peace of mind, as the T5 is fully FOPS (falling object protection system) compliant, to guard against injury from falling objects.



Electro Command models	730TL	740TL	750TL
Max. lift height (m)	3.7	3.7	4
Max. lift capacity (kg)	2060	2539	2304
T5.100	●	○	○
T5.110	○	●	○
T5.120	○	○	●

● Recommended ○ Optional

Fast coupling and decoupling

Attachments can be quickly and easily connected courtesy of quick coupling technology. Just one coupling safely secures the attachments for reduced time in the yard and more time on the job. Do you always need your loader? Reduce your operating costs by removing it when not required, after all, it's got its own built-in stands for safe storage and a single quick-attach connector further speeds up the process.

Hydraulic power and PTO flexibility.

The standard MegaFlow™ pump delivers an impressive 84 litres/minute of hydraulic flow from a single pump, so you've got the flow on tap to breeze through intensive hydraulic applications such as bale wrapping and hedge cutting. The new load-sensing mid-mount valves, controlled by the ergonomic joystick, make for super-fast loader cycle times which are uncompromised when steering, which remains light and precise, thanks to the dedicated 43 litre/minute services pump.



Mechanical or electronic, the choice is yours

The T5 can be specified with up to two mid-mount remote valves to operate specialised equipment or a loader. They are controlled via the cab-mounted integrated joystick. A mechanical joystick offers robust functionality with positive engagement or select the electronic option for precise finger-tip actuation. Both versions feature integrated de clutch and up gear and down gear shift buttons.

Accurate electronic draft control

The ergonomic EDC mouse nestles perfectly under the right hand and features acclaimed New Holland design for one-handed operation. Control linkage height and depth for uniform fields, time after time. The fast linkage raise and lower button makes returning an implement to work during a headland turn even easier and faster, speeding up cultivation for improved productivity.



PTO: choice and soft start

A full range of PTO speeds can be selected using the ergonomic lever situated to the right of the operator. Options include 540, 540 ECO, 1000 and 1000 ECO achieved at engine speeds as low as a mere 1500rpm for reduced fuel consumption and quiet in-cab operation. A ground-speed PTO can also be specified, and it is engaged via a dedicated lever to the left of the operator.



Soft Start and Auto PTO operation

Soft Start PTO is engaged via a dedicated switch on the Command Arc, and it helps protect both the tractor and the implement to prevent sudden shock loads. Optional Auto PTO can be selected to automatically disengage the PTO as the rear linkage is raised above a pre-set position. This protects the PTO shaft and tractor. The system will also re-engage drive as the linkage is lowered.

360°: T5 Electro Command.

The new T5 range has been designed to spend more time working and less time in the yard. All service points are easy to access, and super long service intervals mean they will spend more time in their natural environment: the field!

Single piece engine hood opens wide for full service access.

The engine air filter is easy to check, clean or replace, with no need for tools.

Engine oil check and fill points are easy to reach, with no need to lift the hood. This makes routine checks faster and servicing simpler.

Cooling package opens out to make cleaning faster and easier.

Top up the screen wash bottle through the rear window.

Cab air filter can be easily changed.

The 12 litre AdBlue tank's filler neck is narrower than that of the standard fuel tank, which prevents inadvertent filling with fuel.

Hydraulic oil levels can be viewed via sight glass at the rear of the tractor.

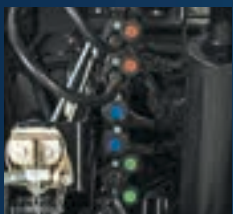

Dealer Installed Accessories

A comprehensive range of approved accessories to optimise machine performance in all conditions can be supplied and fitted by your dealer.

New Holland Services.



Finance tailored to your business

CNH Industrial Capital, the financial services company of New Holland, is well established and respected within the agricultural sector. Advice and finance packages tailored to your specific needs are available. With CNH Industrial Capital, you have the peace of mind that comes from dealing with a financing company that specialises in agriculture.



Trained to give you the best support

Your dedicated New Holland dealer technicians receive regular training updates. These are carried out both through on-line courses as well as intensive classroom sessions. This advanced approach ensures your dealer will always have the skills needed to look after the latest and most advanced New Holland products.



Service Plus – because your peace of mind is priceless

Service Plus programme provides owners of New Holland agricultural machinery with repair services covering your machinery over the Manufacturer's contractual Warranty. Maximum control over operating costs, repairs completed by authorized NH Dealers using NH genuine parts, higher re-sale value of your machine, transferable coverage. You can choose from three levels of coverage:



Silver Cover - Powertrain

Gold Cover - Extended

Platinum Cover - Full Repair

- The number of years of the cover: two, three, four or five years
- The number of hours of use (or number of bales for balers)
- Many other options to tailor the programme and meet your expectations

Please refer to your Dealer how to take out a Service Plus contract for your machinery



New Holland Agriculture T5 Electro Command range App

With this New Holland Agriculture new product App, you will be able to discover all the features, benefits and applications of this brand-new T5 Electro Command tractor range. Scan here to download the App.

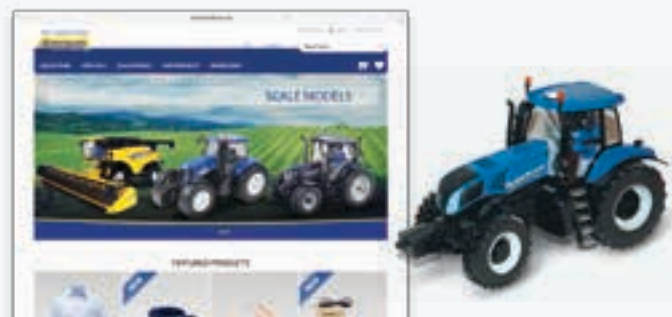

New Holland Style

Want to make New Holland a part of your everyday life? Browse the comprehensive selection on www.newhollandstyle.com. A whole range of items are available including hard wearing work clothing and a vast selection of scale models, together with so much more. New Holland. As individual as you.

T5 Electro Command models	T5.100	T5.110	T5.120
Engine*	F5C	F5C	F5C
No. of cylinders / Aspiration / Valves	4 / T / 4	4 / T / 4	4 / T / 4
Compliant with engine emissions regulations	Tier 4B / Stage 4	Tier 4B / Stage 4	Tier 4B / Stage 4
ECObLue™ Compact HI-eSCR system* (Selective Catalytic Reduction)	●	●	●
Fuel System - High Pressure Common Rail	●	●	●
Capacity (cm ³)	3400	3400	3400
Bore and Stroke (mm)	99x110	99x110	99x110
Approved Biodiesel blend**	B7	B7	B7
Max. horsepower - ISO TR14396 - ECE R120 [kW/hp(CV)]	73/99	79/107	86/117
Rated horsepower - ISO TR14396 - ECE R120 [kW/hp(CV)]	73/99	79/107	86/117
Rated engine speed (rpm)	2300	2300	2300
Max. torque - ISO TR14396 (Nm)	430@1500rpm	468@1500rpm	491@1500rpm
Torque rise (%)	42	42	37
Engine Speed Management	●	●	●
Diesel tank capacity (Litres)	165	165	165
AdBlue tank capacity (Litres)	12	12	12
Service interval (hours)	600	600	600
Electro Command™ transmission (40kph ECO)	●	●	●
3 Speed shuttle aggressiveness settings	●	●	●
Powershuttle lever	●	●	●
Number of gears (FxR)	16x16	16x16	16x16
Minimum speed (kph)	2.27	2.27	2.27
IntelliShift™ System	●	●	●
Electro Command™ transmission [Optional Super Creeper (40kph ECO)]	○	○	○
3 Speed shuttle aggressiveness settings	●	●	●
Powershuttle lever	●	●	●
Number of gears (FxR)	32x32	32x32	32x32
Minimum speed (kph)	0.28	0.28	0.28
IntelliShift™ System	●	●	●
Electrical			
12 volt alternator Standard / Optional (Amps)	120 / 200	120 / 200	120 / 200
Standard battery capacity (CCA / Ah)	800 / 140	800 / 140	800 / 140
Axles			
4WD front axle	●	●	●
Terraglide™ front axle suspension	○	○	○
Steering angle (°)	55	55	55
Dynamic Front Fenders	○	○	○
Terralock™ functions (Auto Diff / Auto 4WD)	●	●	●
Turning radius (mm)	4960	4960	4960
Hydraulics			
Fixed Displacement	●	●	●
MegaFlow™ option main pump flow / pressure @ 2300rpm (Lpm / Bar)	84 / 190	84 / 190	84 / 190
MegaFlow™ option services pump flow / pressure @ 2300rpm (Lpm / Bar)	43 / 170	43 / 170	43 / 170
Electronic Draft Control (EDC)	●	●	●
Remote valves			
Type	Deluxe	Deluxe	Deluxe
Max. no. rear valves / diverter	3 / 1	3 / 1	3 / 1
Max. no. rear remote outlets	8	8	8
Max. no. mid mount valves (Mechanical and Electro Hydraulic)	2	2	2
Max. no. mid mount outlets	4	4	4
Mid mount joystick control (Mechanical and Electro Hydraulic)	○	○	○
Linkage			
Rear linkage category	2	2	2
Max. lift capacity at ball ends (kg)	5420	5420	5420
Max. lift capacity through the range (610mm behind ball ends) (kg)	4730	4730	4730
Front linkage lift capacity at ball ends (through the range) (kg)	2250	2250	2250
Front Loader Ready	○	○	○
Integrated loader joystick	○	○	○
PTO			
Electro hydraulic PTO engagement	●	●	●
Soft Start PTO activation	●	●	●
Auto PTO management	○	○	○
Engine speed at:			
540 / 1000 (rpm)	1938 / 1926	1938 / 1926	1938 / 1926
540 / 540E / 1000 (rpm)	1938 / 1535 / 1926	1938 / 1535 / 1926	1938 / 1535 / 1926
540E / 1000 / 1000E	1535 / 1926 / 1486	1535 / 1926 / 1486	1535 / 1926 / 1486
Ground speed	○	○	○

T5 Electro Command models	T5.100	T5.110	T5.120
Brakes			
Hydraulic Trailer Brakes	●	●	●
Optional Pneumatic Tractor Brakes	○	○	○
Cab			
Deluxe VisionView™ cab with FOPS - OECD Code 10 Level 1	●	●	●
Deluxe VisionView™ cab category level - EN 15695	2	2	2
4 Halogen lighting pack	●	●	●
8 LED lighting pack	○	○	○
High visibility roof hatch	●	●	●
Rear window wiper / washer	●	●	●
Standard mechanical suspension with seat belt	●	●	●
Deluxe air suspension seat with seat belt	○	○	○
Premium air suspension seat with seat belt	○	○	○
Instructor seat with seat belt	●	●	●
Tilting steering column	○	○	○
Air conditioning	●	●	●
Air Recirculation Filters	●	●	●
MP3 Bluetooth radio (hands free phone calls)	○	○	○
Telescopic Shatterproof Mirrors	○	○	○
Telescopic mirrors with wide angle view	○	○	○
Comfort Ride™ cab suspension	○	○	○
Fender mounted external PTO & Linkage controls	○	○	○
Performance Monitor with enhanced key pad	○	○	○
Cab monitor mounting bracket	○	○	○
IntelliView™ III colour monitor	○	○	○
ISO 11783 connector	○	○	○
Camera connection	○	○	○
IntelliSteer® lite guidance system	○	○	○
PLM® Connect telematics	○	○	○
ISOBUS Class II navigated	○	○	○
Optimum Deluxe VisionView™ cab noise level - 77/311EEC (dB(A))		74	
Factory Fit Rotating Beacons (1 / 2)	○	○	○
Weights			
Minimum unballasted / shipping weights (kg)	4550 / 5350	4550 / 5350	4550 / 5350
Max. permissible weight (kg)	8000	8000	8000

● Standard ○ Optional – Not available

* Developed by FPT Industrial ** Biodiesel blend must fully comply with the latest fuel specification EN14214:2009 and operation is in accordance with operator manual guidelines



Dimensions

With rear tyres***		16.9R34	16.9R38
A Overall length inc. front support to rear linkage (mm)		4161	4161
B Min. width (mm)		1992	1992
C Height at centre of rear axle to top of cab (mm)		1945	1945
D Min. overall height (with or without Comfort Ride™ cab suspension) (mm)		2695	2745
E Wheelbase (mm)		2380	2380
F Track width (min. / max.) (mm)		1320 / 2246	1320 / 2246
G Ground clearance (mm)		315 - 415	315 - 415

*** Rear tyres other than those mentioned are available: 600/65R34, 540/65R38, 540/65R34, 520/70R34, 480/70R38, 480/70R34, 460/85R34, 420/85R38, 420/85R34, 380/80R38, 340/85R38, 18.4R34, 14.9R38, 13.6R38

New Holland Top Service: customer support and customer information.



Top Availability

If you need information, or have an out of hours question, ring our toll-free number*. All day, every day, we are just a call away.



Top Speed

Express parts delivery: when you need it, where you need it!



Top Priority

Fast-track solution during the season: because your harvest can't wait!



Top Satisfaction

We drive and track the solution you need, keeping you informed: until you are 100% satisfied!



For more details, ask your New Holland dealer!

* Calls to the Top Service team are free from landlines in the United Kingdom and Republic of Ireland. UK-based mobile calls are also free, but Republic of Ireland mobile users should call 01 2421881 and this will be charged at your standard network rate.

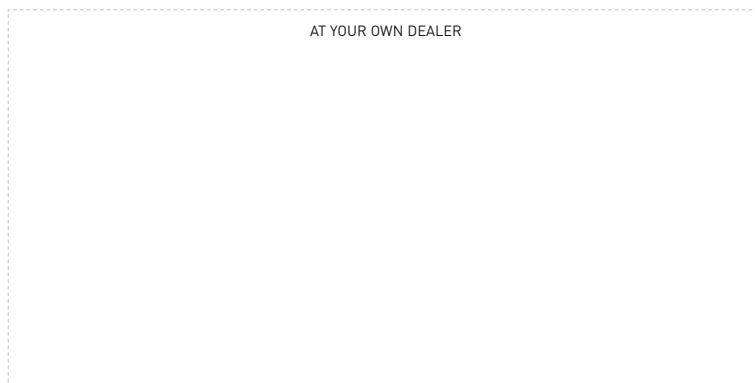

www.newholland.com/uk - www.newholland.com/ie

